

P-Channel Enhancement Mode Power MOSFET

MTB050P10J3

BV_{DSS}	-100V
I_D@V_{GS}=-10V, T_C=25°C	-24A
I_D@V_{GS}=-10V, T_C=100°C	-17A
I_D@V_{GS}=-10V, T_A=25°C	-4.1A
I_D@V_{GS}=-10V, T_A=70°C	-3.3A
R_{DS(ON)}@V_{GS}=-10V, I_D=-15A	45 mΩ (typ)
R_{DS(ON)}@V_{GS}=-4.5V, I_D=-12A	51 mΩ (typ)

Features

- Single Drive Requirement
- Low On-resistance
- Fast switching Characteristic
- Pb-free lead plating and halogen-free package

Symbol

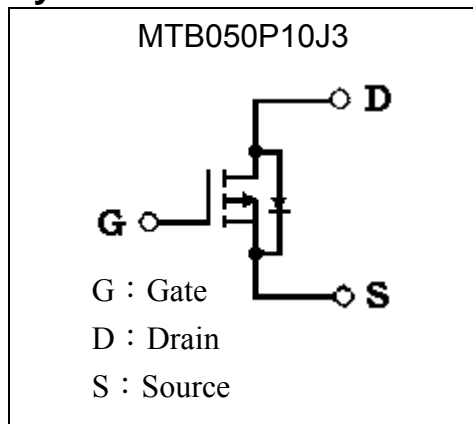

Outline

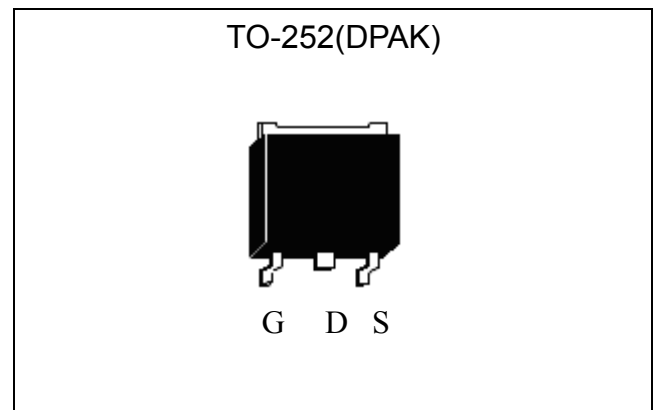

Ordering Information

Device	Package	Shipping
MTB050P10J3-0-T3-G	TO-252 (Pb-free lead plating and halogen-free package)	2500 pcs / Tape & Reel

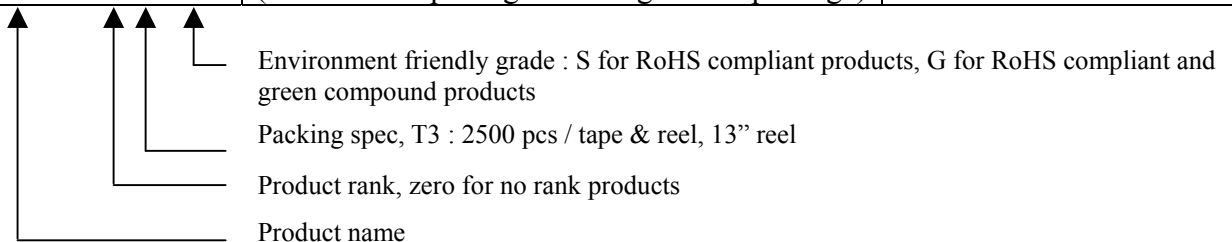

**Absolute Maximum Ratings** (Ta=25°C)

Parameter		Symbol	Limits	Unit
Drain-Source Voltage		V _{DS}	-100	V
Gate-Source Voltage		V _{GS}	±20	
Continuous Drain Current @V _{GS} =-10V, T _C =25°C (Note1)		I _D	-24	A
Continuous Drain Current @V _{GS} =-10V, T _C =100°C (Note1)			-17	
Continuous Drain Current @V _{GS} =-10V, T _A =25°C (Note4)			-4.1	
Continuous Drain Current @V _{GS} =-10V, T _A =70°C (Note4)			-3.3	
Pulsed Drain Current (Note3)		I _{DM}	-96	
Power Dissipation	T _C =25°C (Note1)	P _D	75	W
	T _C =100°C (Note1)		37.5	
	T _A =25°C (Note2)	P _D SM	2	
	T _A =70°C (Note2)		1.3	
Single Pulse Avalanche Energy @ L=1mH, I _{AS} =-24A, V _{DD} =-50V		E _{AS}	288	mJ
Single Pulse Avalanche Current		I _{AS}	-24	A
Operating Junction and Storage Temperature		T _j , T _{stg}	-55~+175	°C

Thermal Data

Parameter	Symbol	Value	Unit
Thermal Resistance, Junction-to-case, max	R _{th,j-c}	2	°C/W
Thermal Resistance, Junction-to-ambient, max (Note2)	R _{th,j-a}	62.5	
Thermal Resistance, Junction-to-ambient, max (Note4)		90	

- Note : 1. The power dissipation P_D is based on T_{J(MAX)}=175°C, using junction-to-case thermal resistance, and is more useful in setting the upper dissipation limit for cases where additional heatsinking is used.
2. The value of R_{θJA} is measured with the device mounted on 1 in² FR-4 board with 2 oz. copper, in a still air environment with T_A=25°C. The power dissipation P_DSM is based on R_{θJA} and the maximum allowed junction temperature of 150°C. The value in any given application depends on the user's specific board design.
3. Repetitive rating, pulse width limited by junction temperature T_{J(MAX)}=175°C. Ratings are based on low frequency and low duty cycles to keep initial T_J=25°C.
4. When mounted on the minimum pad size recommended (PCB mount), t≤10s.

Characteristics (T_j=25°C, unless otherwise specified)

Symbol	Min.	Typ.	Max.	Unit	Test Conditions
Static					
BV _{DSS}	-100	-	-	V	V _{GS} =0V, I _D =-250μA
ΔBV _{DSS} /ΔT _j	-	-0.08	-	V/°C	Reference to 25°C, I _D =-250μA
V _{GS(th)}	-1.0	-	-2.5	V	V _{DS} = V _{GS} , I _D =-250μA
G _{FS}	-	32.8	-	S	V _{DS} = -5V, I _D = -20A
I _{GSS}	-	-	±100	nA	V _{GS} =±20V
I _{DSS}	-	-	-1	μA	V _{DS} = -80V, V _{GS} = 0V
I _{DSS}	-	-	-25		V _{DS} = -80V, V _{GS} = 0V, T _j =70°C
*R _{DS(ON)}	-	45	60	mΩ	V _{GS} = -10V, I _D = -15A
*R _{DS(ON)}	-	51	72		V _{GS} = -4.5V, I _D = -12A
Dynamic					
*Q _g	-	51	-	nC	V _{DS} =-80V, I _D =-15A, V _{GS} =-10V
*Q _{gs}	-	6.5	-		
*Q _{gd}	-	14.3	-		
*t _{d(ON)}	-	13	-	ns	V _{DS} =-50V, I _D =-15A, V _{GS} =-10V, R _G =2.7Ω
*t _r	-	21.6	-		
*t _{d(OFF)}	-	66.2	-		
*t _f	-	15.2	-		
C _{iss}	-	2421	-	pF	V _{GS} =0V, V _{DS} =-25V, f=1MHz
C _{oss}	-	211	-		
C _{rss}	-	93	-		
R _g	-	3.6	-		
Source-Drain Diode					
*I _S	-	-	-24	A	
*V _{SD}	-	-0.83	-1.2	V	I _S =-15A, V _{GS} =0V
*t _{rr}	-	25	-	ns	I _F =-15A, V _{GS} =0, dI _F /dt=-100A/μs
*Q _{rr}	-	33	-	nC	

*Pulse Test : Pulse Width ≤300μs, Duty Cycles≤2%

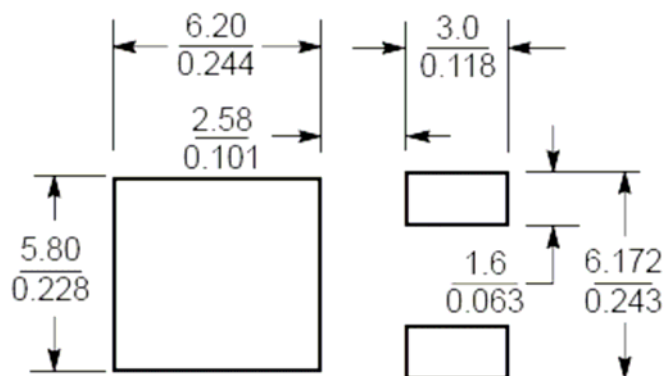
Recommended soldering footprint

 Unit ($\frac{\text{mm}}{\text{inch}}$)

Typical Characteristics

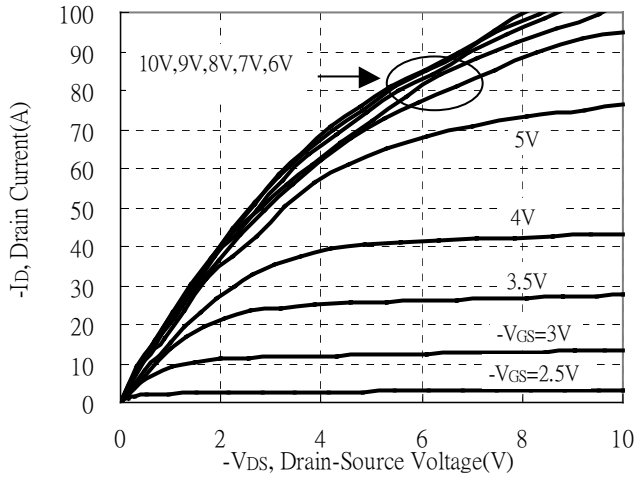
Typical Output Characteristics

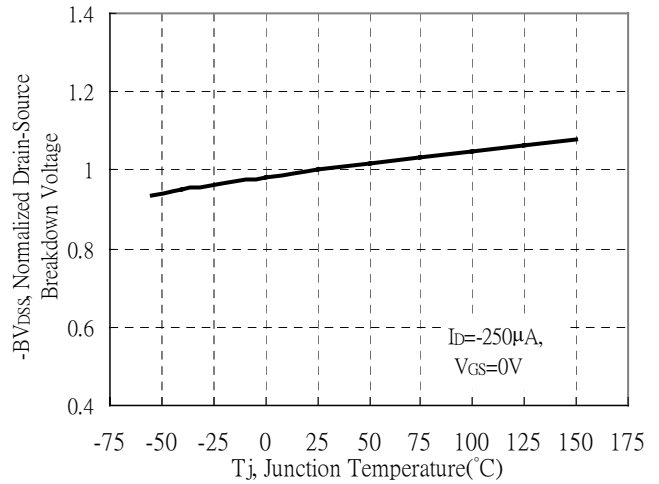

Brekdown Voltage vs Ambient Temperature



Static Drain-Source On-State resistance vs Drain Current

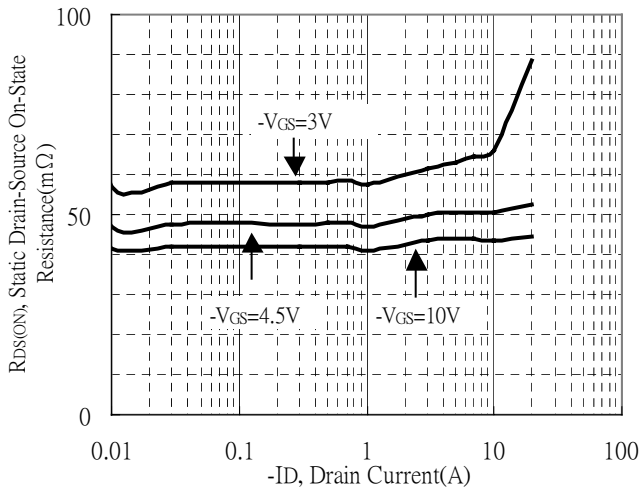

Reverse Drain Current vs Source-Drain Voltage

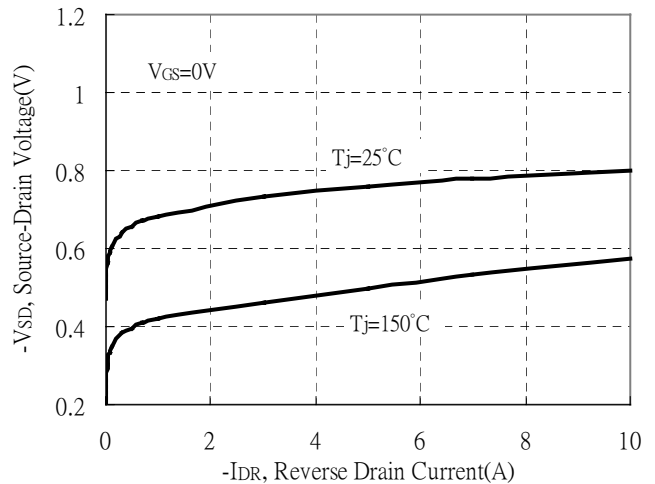

Static Drain-Source On-State Resistance vs Gate-Source Voltage

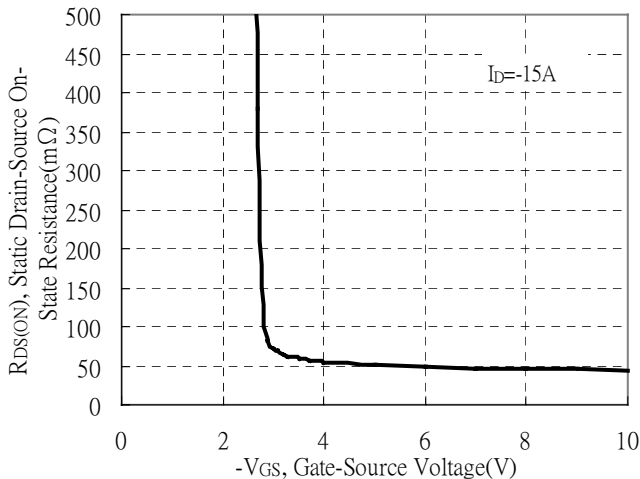

Drain-Source On-State Resistance vs Junction Teperature

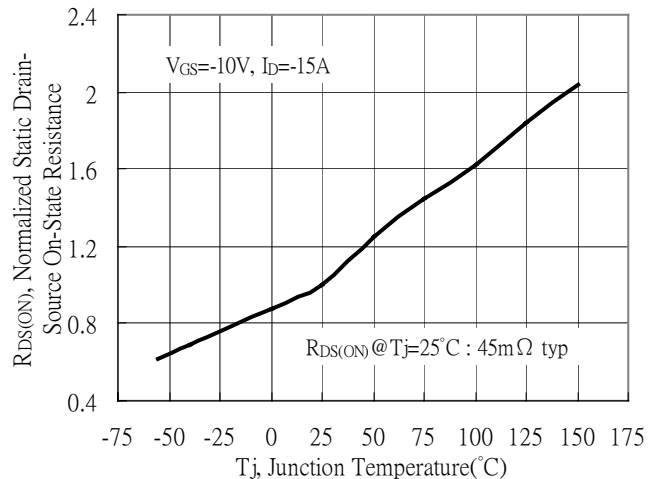

Typical Characteristics(Cont.)

Capacitance vs Drain-to-Source Voltage

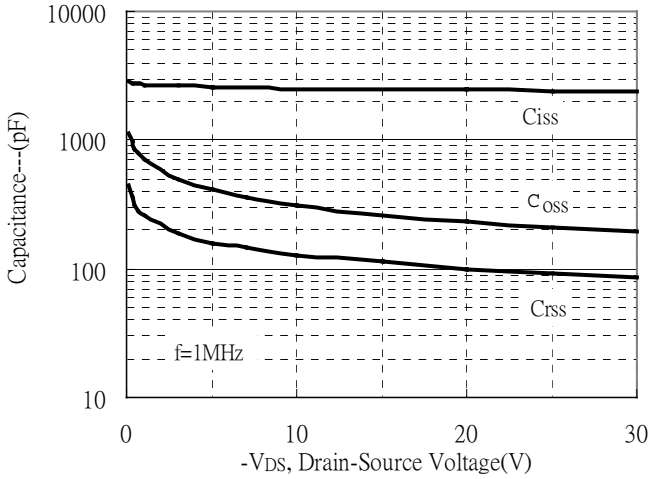

Threshold Voltage vs Junction Temperature

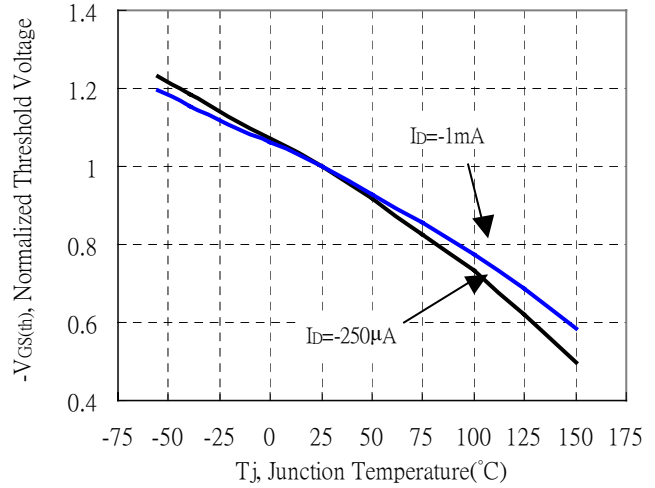

Forward Transfer Admittance vs Drain Current

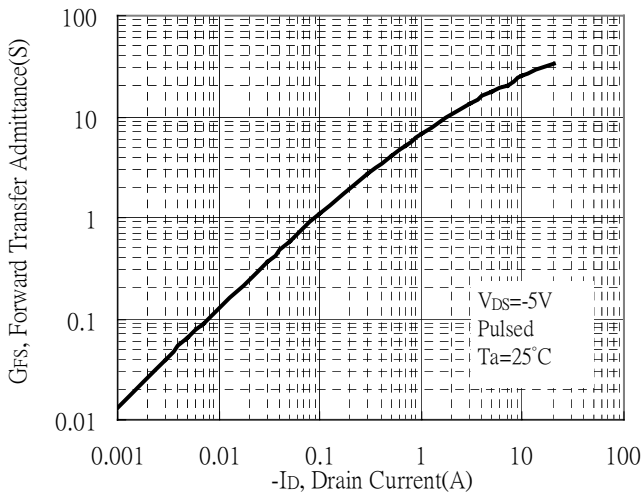

Gate Charge Characteristics

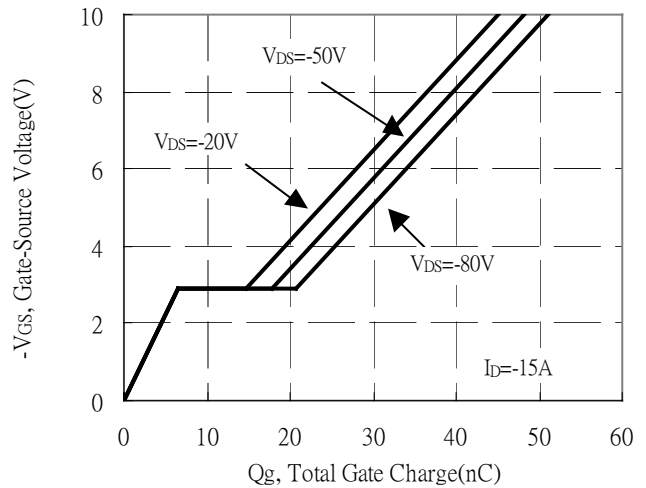

Maximum Safe Operating Area

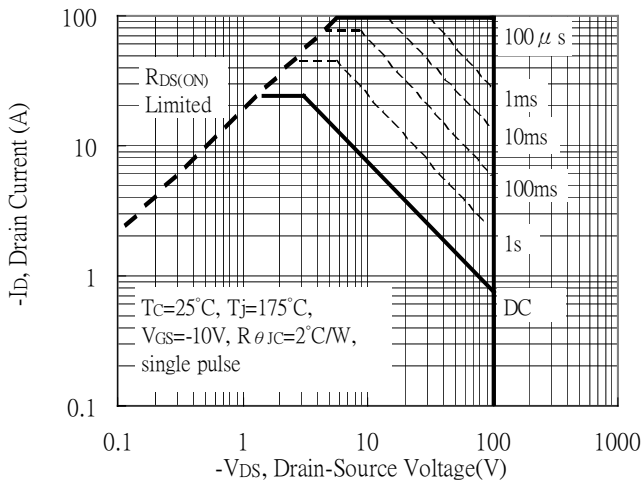

Maximum Drain Current vs Case Temperature

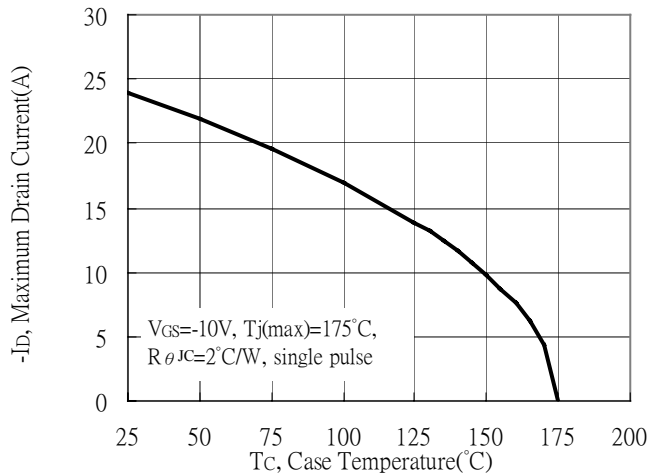



Typical Characteristics(Cont.)

Single Pulse Power Rating, Junction to Case

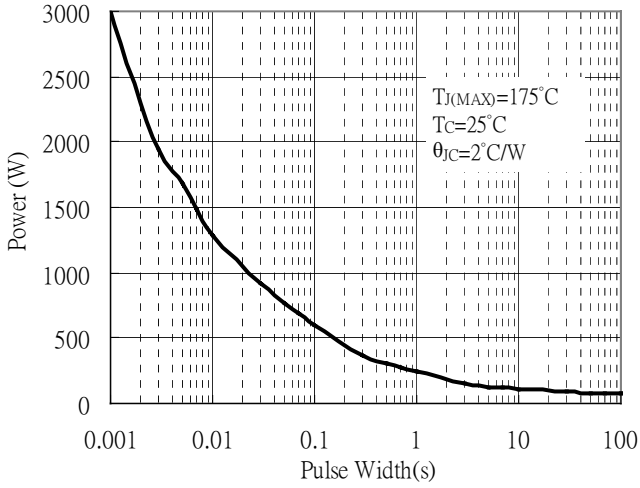

Typical Transfer Characteristics

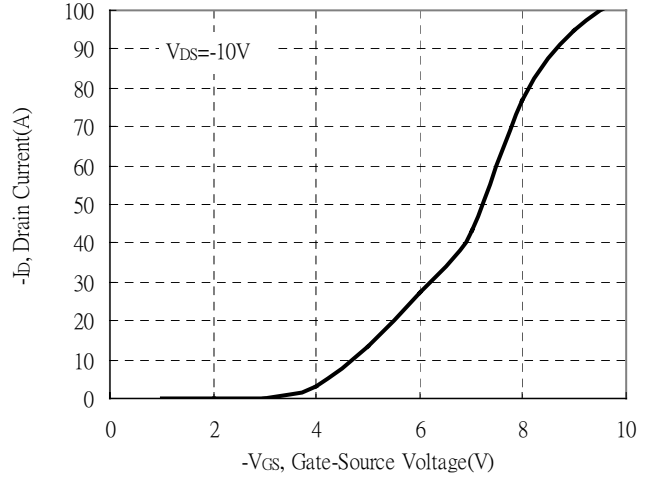

Power Derating Curve

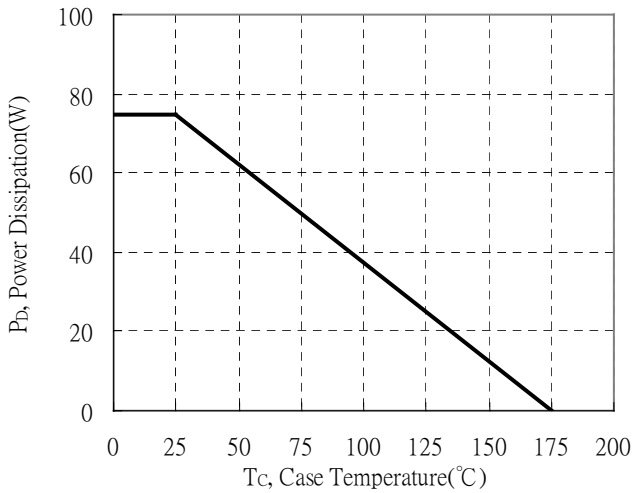

Power Derating Curve

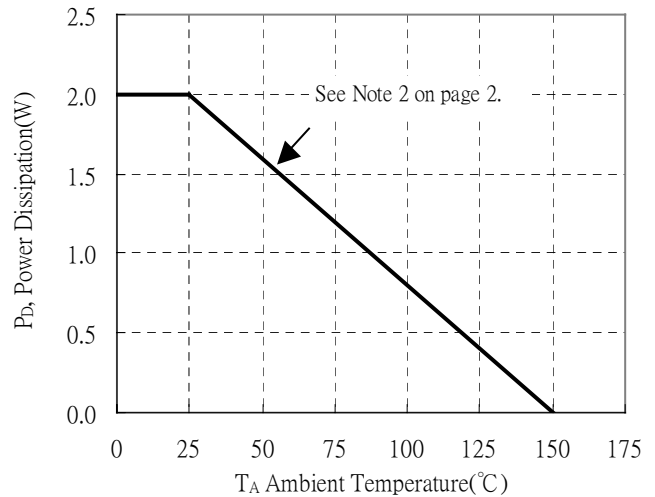

Transient Thermal Response Curves

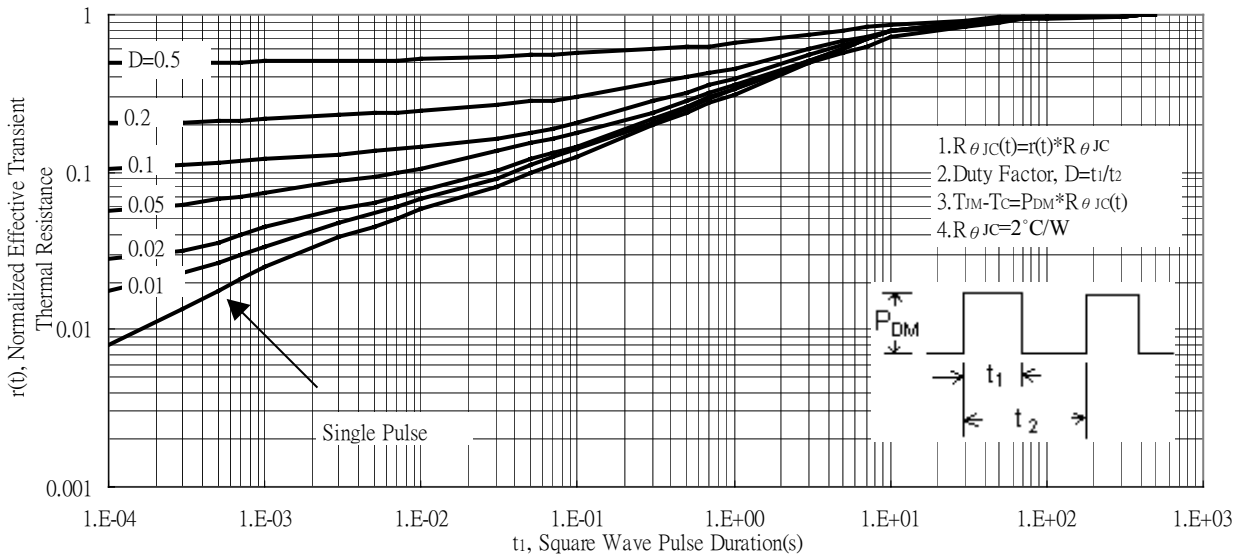

Reel Dimension

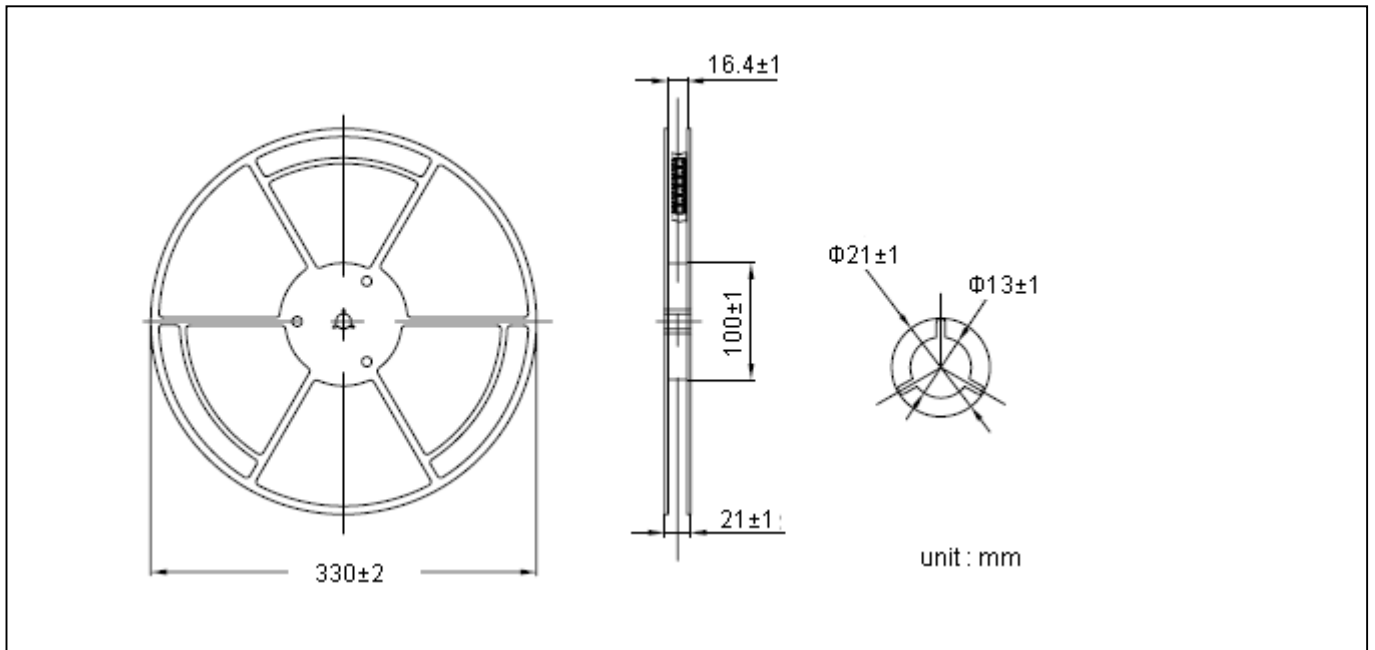

Carrier Tape Dimension

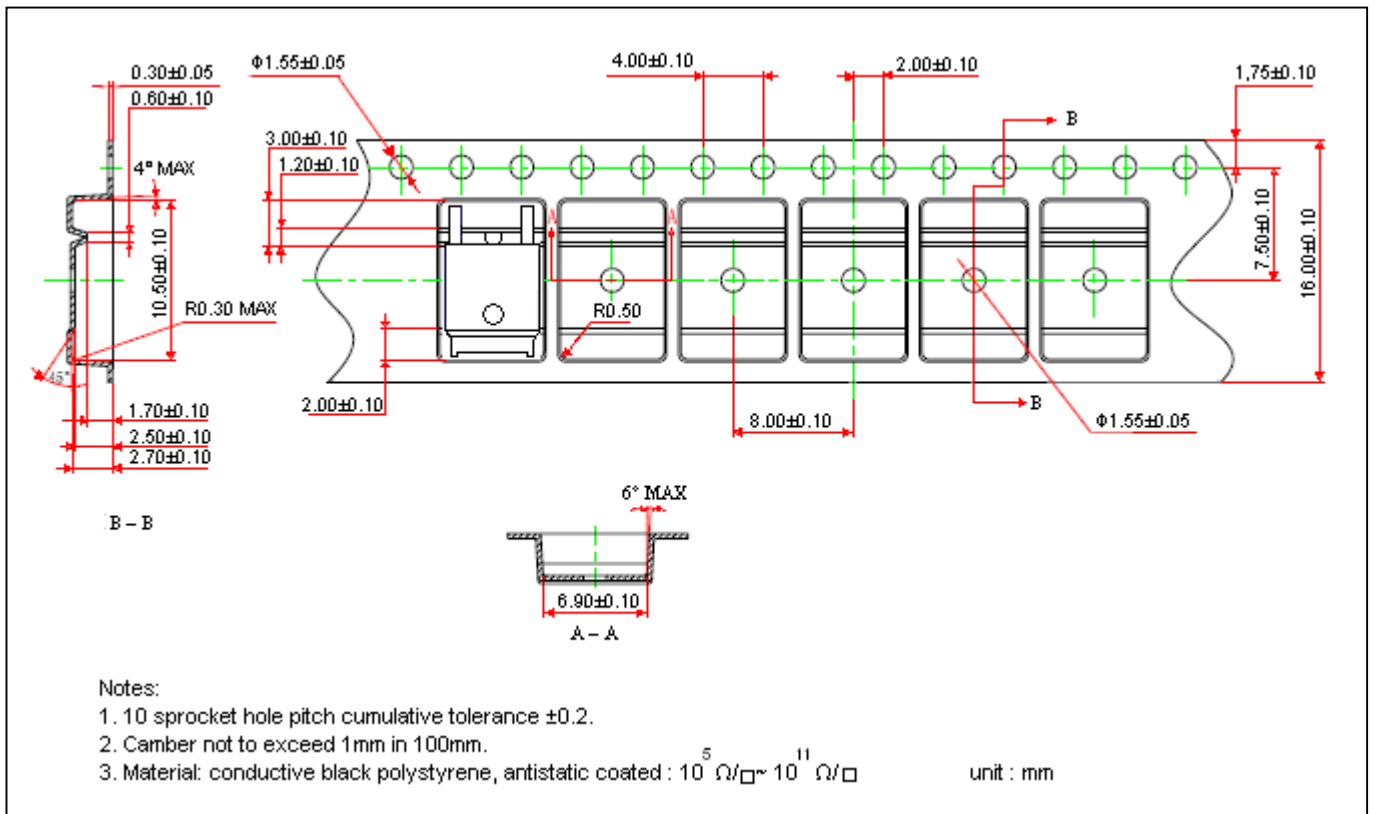

Recommended wave soldering condition

Product	Peak Temperature	Soldering Time
Pb-free devices	260 +0/-5 °C	5 +1/-1 seconds

Recommended temperature profile for IR reflow

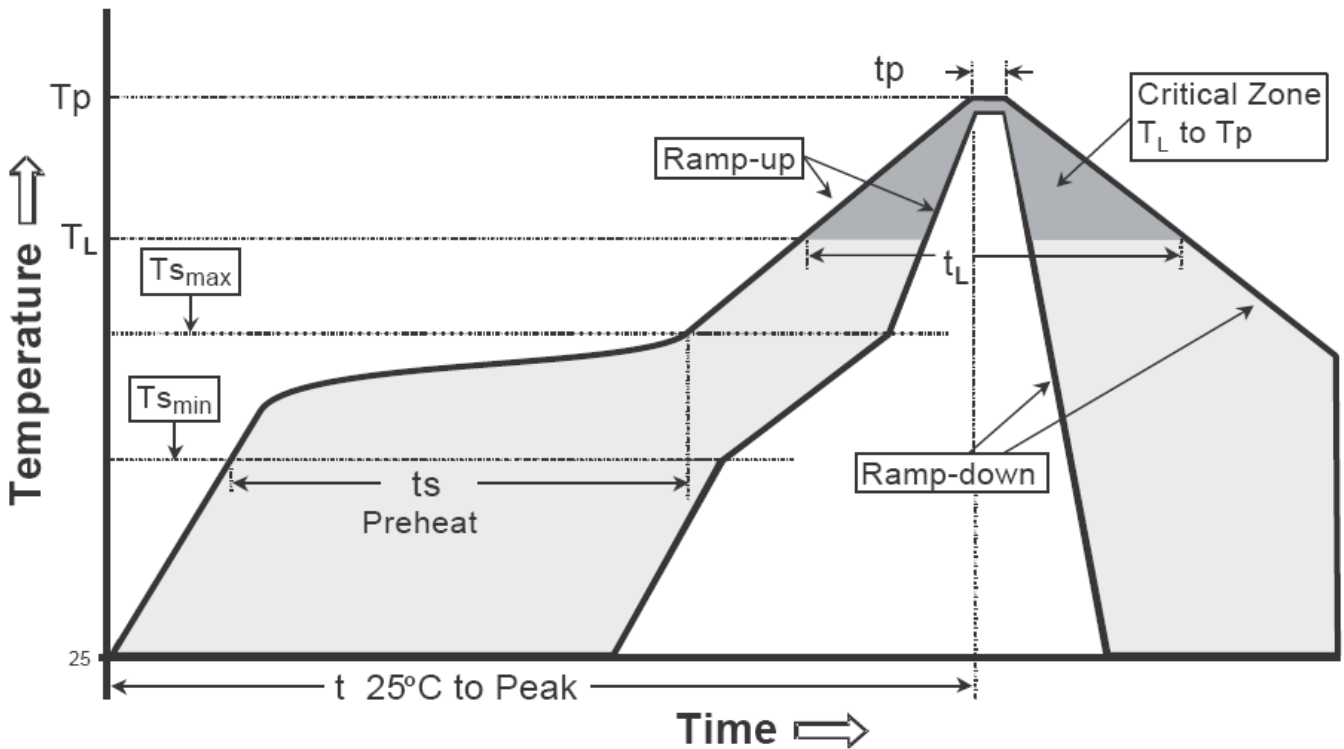

Profile feature	Sn-Pb eutectic Assembly	Pb-free Assembly
Average ramp-up rate (Tsmax to Tp)	3°C/second max.	3°C/second max.
Preheat		
-Temperature Min(Ts min)	100°C	150°C
-Temperature Max(Ts max)	150°C	200°C
-Time(ts min to ts max)	60-120 seconds	60-180 seconds
Time maintained above:		
-Temperature (Tl)	183°C	217°C
- Time (tL)	60-150 seconds	60-150 seconds
Peak Temperature(TP)	240 +0/-5 °C	260 +0/-5 °C
Time within 5°C of actual peak temperature(tp)	10-30 seconds	20-40 seconds
Ramp down rate	6°C/second max.	6°C/second max.
Time 25 °C to peak temperature	6 minutes max.	8 minutes max.

Note : All temperatures refer to topside of the package, measured on the package body surface.

TO-252 Dimension

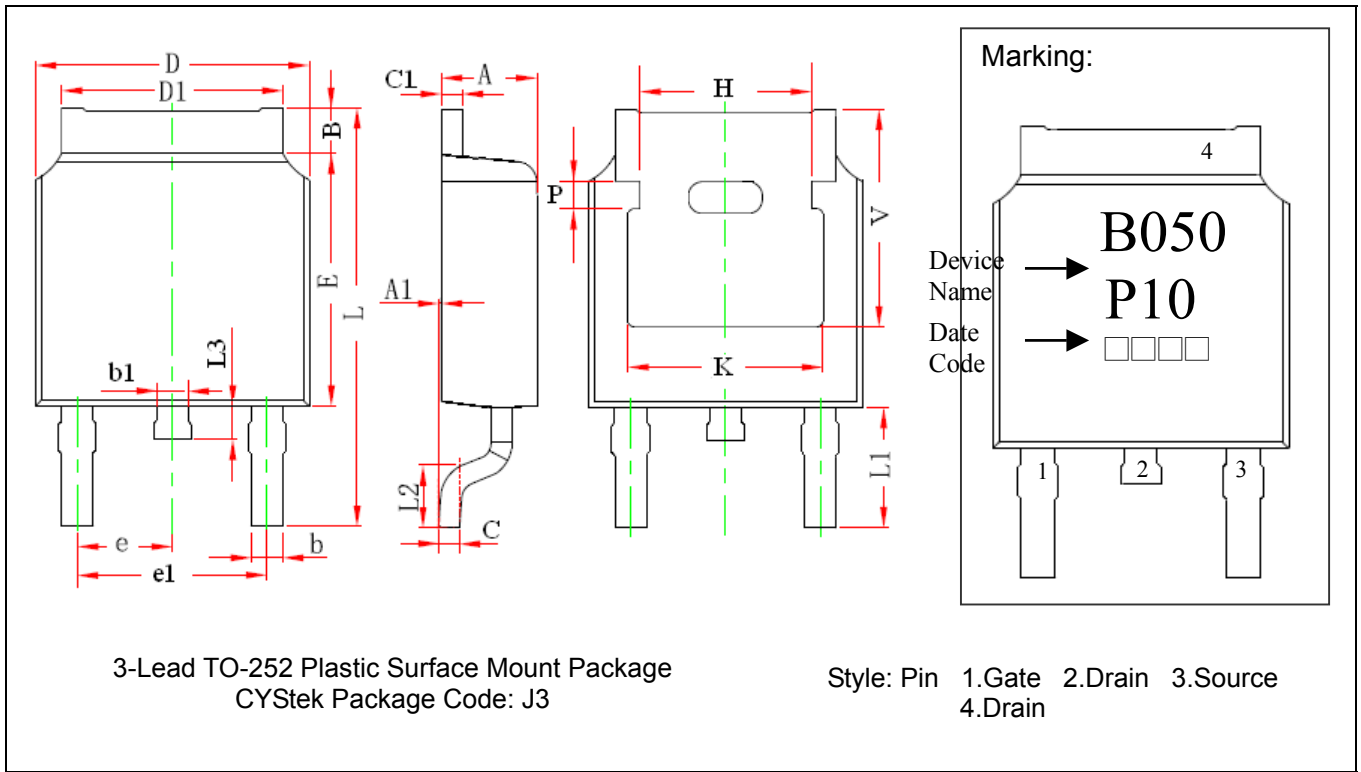

DIM	Inches		Millimeters		DIM	Inches		Millimeters	
	Min.	Max.	Min.	Max.		Min.	Max.	Min.	Max.
A	0.087	0.094	2.200	2.400	e	0.086	0.094	2.186	2.386
A1	0.000	0.005	0.000	0.127	e1	0.172	0.188	4.372	4.772
B	0.039	0.048	0.990	1.210	H	0.163	REF	4.140	REF
b	0.026	0.034	0.660	0.860	K	0.190	REF	4.830	REF
b1	0.026	0.034	0.660	0.860	L	0.386	0.409	9.800	10.400
C	0.018	0.023	0.460	0.580	L1	0.114	REF	2.900	REF
C1	0.018	0.023	0.460	0.580	L2	0.055	0.067	1.400	1.700
D	0.256	0.264	6.500	6.700	L3	0.024	0.039	0.600	1.000
D1	0.201	0.215	5.100	5.460	P	0.026	REF	0.650	REF
E	0.236	0.244	6.000	6.200	V	0.211	REF	5.350	REF

Notes: 1.Controlling dimension: millimeters.
 2.Maximum lead thickness includes lead finish thickness, and minimum lead thickness is the minimum thickness of base material.
 3.If there is any question with packing specification or packing method, please contact your local CYStek sales office.

Material:

- Lead : Pure tin plated.
- Mold Compound: Epoxy resin family, flammability solid burning class: UL94V-0.

Important Notice:

- All rights are reserved. Reproduction in whole or in part is prohibited without the prior written approval of CYStek.
- CYStek reserves the right to make changes to its products without notice.
- CYStek **semiconductor products are not warranted to be suitable for use in Life-Support Applications, or systems.**
- CYStek assumes no liability for any consequence of customer product design, infringement of patents, or application assistance.